

NAV-TV

INTERFACING THE FUTURE

3950 NW 120th Ave, Coral Springs, FL 33065 TEL 561-955-9770 FAX 561-955-9760
www.nav-tv.com info@nav-tv.com

BHM
02/20/20
NTV-DOC176

Bentley MOD

NTV-MOD031



Overview

The Bentley R-CAM adds 2 inputs (including a backup camera input) to the factory media screen in select Bentley CT/GT vehicles **following a radio modification**. With additional parts, HDMI input or a SmartPhone interface can be added as well (contact NAV-TV for more information)

Kit Content

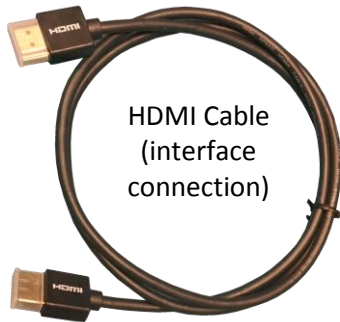

HDMI Cable
(interface
connection)



BENTLEY Interface



Remote Control
(menu control)

HD-LINK Optional KIT800

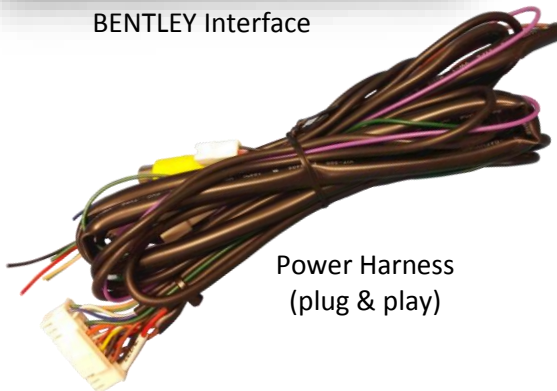

Power Harness
(plug & play)



IR Receiver

Agreement: End user agrees to use this product in compliance with all State and Federal laws. NAV-TV Corp. would not be held liable for misuse of its product. If you do not agree, please discontinue use immediately and return product to place of purchase. This product is intended for off-road use and passenger entertainment only.

Interface Connectors

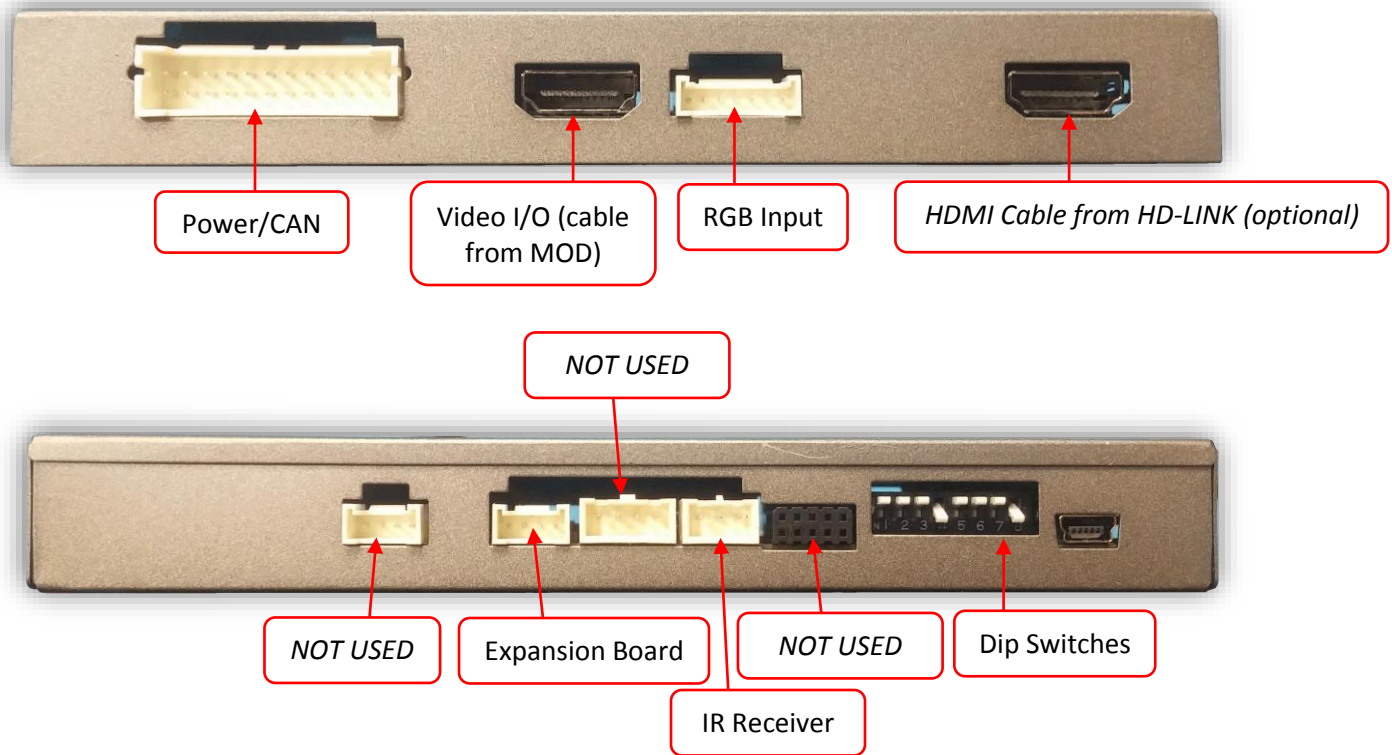

Dip Switch Settings

Dip SW:	1	2	3	4	5	6*	7	8
UP	KEEP UP	Skips V1	Skips V2	RVC OFF	N/A	N/A	N/A	KEEP DOWN
DOWN	KEEP UP	Enables V1	Enables V2	RVC ON	N/A	N/A	N/A	KEEP DOWN



***Note: Disconnect power to the interface before adjusting dip switches or the change will not be implemented.**

Vehicle Connections

1. Connect the male end of the provided Plug & Play CAN-harness to the climate control assembly behind the radio face (circled, red).
2. Connect the factory climate control plug to the female end of the provided Plug & Play harness.
3. Power your camera with a 12v Accessory source, or the *purple wire from this interface supplies 12v (+) when in reverse only*.
4. Connect your camera's signal to the RCA on the provided harness labeled 'CAMERA'.
5. Connect the Power connector to the port on the Bentley interface labeled 'POWER CAN'.
6. Connect the provided HDMI cable to the small circuit board underneath the radio (circled, yellow), and the other end to the port on the interface labeled 'VIDEO OUT'.
7. **Optional:** The *green wire* from the harness will switch the screen to the reverse image (when supplied 12v +) in case CAN data is not switching properly.

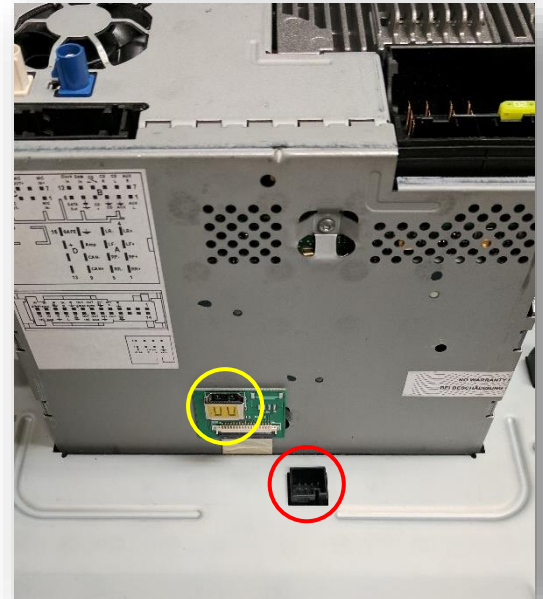

BENTLEY-MOD Operation

- Once all connections are made, placing the vehicle in reverse will show the connected rear camera with dynamic guidelines for convenience.
- To activate HDMI input (requires KIT800) or front camera (if added and turned on in menu), press the **NAV** button. Cycling available inputs will follow this order: **OEM>HDMI>FRONT CAMERA>OEM** (only options turned ON in menu will show).



Adding HD-LINK Adapter (HDMI Input)

Follow the instructions below when adding the HDMI adapter (HD-LINK) to enable HDMI input to the OEM screen:

1. Put dip switch #1 in the **DOWN** position.
2. Activate the 'NAV INPUT' by pressing the 'NAV' button on the radio face.
3. Once 'NAV INPUT' shows on the screen, on the remote press the **OK BUTTON 4 times**, then press **POWER**.
4. Navigate to the 'NAVI' section.
 - a. Select 'HDMI' (5 blocks over)
 - b. Choose 'HD95E'
 - c. Press **MODE** on the remote to return and exit the OSD menu (or let it time out).



5. Replace dip switch #1 to the **UP** position.
6. Connect the **black wire** to ground (-) and the **red wire** to ACC power (+) from the main power connector on the **HD-LINK** adapter. The RCA's on this plug provide audio from the HDMI source.

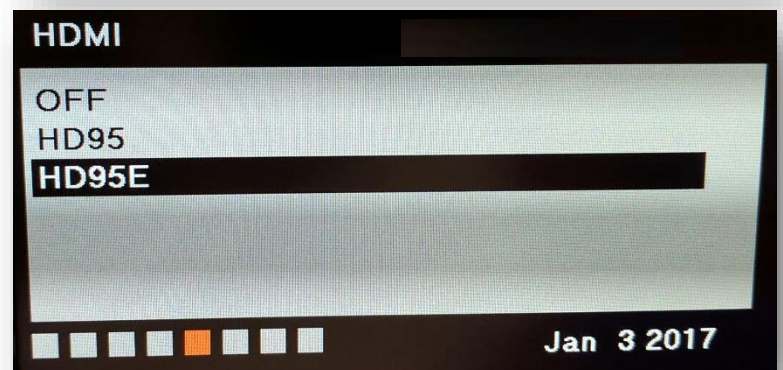
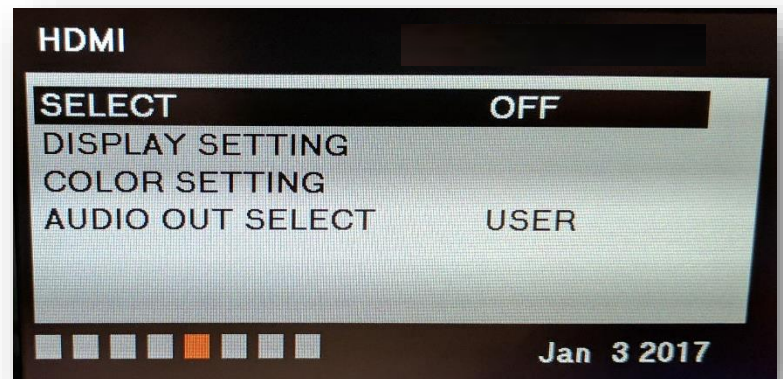

Agreement: End user agrees to use this product in compliance with all State and Federal laws. NAV-TV Corp. would not be held liable for misuse of its product. If you do not agree, please discontinue use immediately and return product to place of purchase. This product is intended for off-road use and passenger entertainment only.

BENTLEY-MOD Menu Adjustments

Before you start:

- The IR-Eye must be connected, (connects to main harness)
- Make sure the car's ignition is on and radio is on
- You must be in **Reverse Camera** mode.
 - **Reverse Camera Mode** adjusts Reverse Camera Settings
- Press the **OK BUTTON 4 times** (numbers will display per press), then press **POWER**.
- The **OSD Menu** will appear on screen (auto-time out in about 5 seconds if no action occurs).



Select
choice &
Return

AUX Video Menu

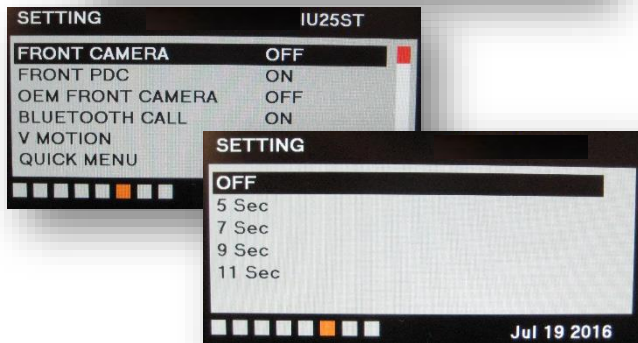
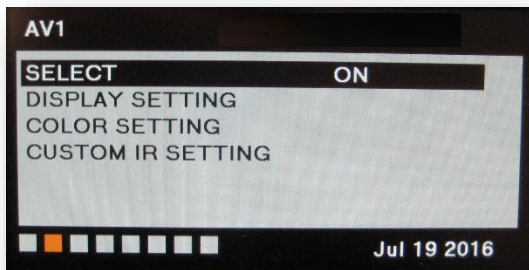

If adding a front camera OR Aux Video source:

1. Disconnect POWER/CAN Harness from interface
2. Place DIP SWITCH 1 in the DOWN position, reconnect power
3. Press the **NAV** button on the radio to activate 'NAVI' screen
4. Press **OK** button on remote 4 times, then press **POWER**

If the user wants only an AUX video input **without front camera**, set **AV1 SELECT** to **ON**, scroll to the end (right side) of the menu and exit menu.

FRONT CAMERA setting is used when **the user wants automatic front camera switching**. Options for 5, 7, 9 or 11 seconds are user-selectable for the length of time the front camera input stays active once the vehicle is placed out of reverse.

Once finished with settings, place DIP SWITCH 1 back into the **UP position** and reset power to interface (if this step is not taken, the unused 'NAVI' input will show as an additional video input when cycling video inputs)